



Features

- Epitaxial planar die construction
- Built-in biasing resistors (R_1 : 47k Ω , R_2 : 47k Ω)
- Also available in lead free version
- RoHS compliant with Halogen-free

Mechanical Data

- Case: SOT-23, SOT-323, SOT-523, SOT-723, DFN1006-3
- Molding Compound: UL Flammability Classification Rating 94V-0
- Terminals: Matte tin-plated leads; solderability-per

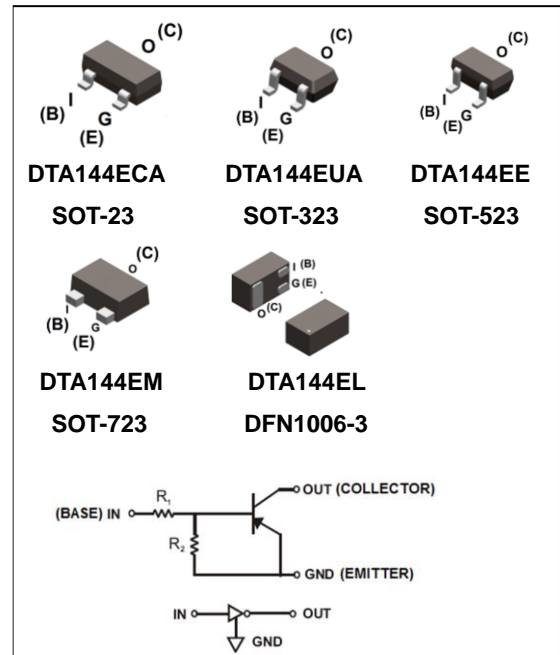

Ordering Information

Part Number	Package	Shipping Quantity	Marking Code
DTA144ECA	SOT-23	3000 pcs / Tape & Reel	16
DTA144EUA	SOT-323	3000 pcs / Tape & Reel	16
DTA144EE	SOT-523	3000 pcs / Tape & Reel	16
DTA144EM	SOT-723	10000 pcs / Tape & Reel	16
DTA144EL	DFN1006-3	10000 pcs / Tape & Reel	16

Maximum Ratings (@ $T_A = 25^\circ\text{C}$ unless otherwise specified)

Parameter	Symbol	Value					Unit
		SOT-23	SOT-323	SOT-523	SOT-723	DFN1006-3	
Supply Voltage	V_{CC}	-50					V
Input Voltage	V_I	-40 to +10					V
Output Current	I_o	-30					mA
Collector Current	$I_{C(Max)}$	-100					mA
Power Dissipation	P_D	200	200	150	100	100	mW
Junction Temperature Range	T_J	-55 ~ +150					$^\circ\text{C}$
Storage Temperature Range	T_{STG}	-55 ~ +150					$^\circ\text{C}$



Electrical Characteristics (@ $T_A = 25^\circ\text{C}$ unless otherwise specified)

Parameter	Symbol	Test Condition	Min.	Typ.	Max.	Unit
Input Voltage	$V_{I(OFF)}$	$V_{CC} = -5\text{V}, I_o = -100\mu\text{A}$	-0.5	-	-	V
Input Voltage	$V_{I(ON)}$	$V_o = -0.3\text{V}, I_o = -2\text{mA}$	-	-	-3	V
Output Voltage	$V_{O(on)}$	$I_o = -10\text{mA}, I_i = -0.5\text{mA}$	-	-	-0.3	V
Input Current	I_i	$V_i = -5\text{V}$	-	-	-0.18	mA
Output Current	$I_{O(off)}$	$V_{CC} = -50\text{V}, V_i = 0\text{V}$	-	-	-0.5	μA
DC Current Gain	G_i	$V_o = -5\text{V}, I_o = -5\text{mA}$	68	-	-	-
Input Resistor	R_1		32.9	47	61.1	k Ω
Resistance ratio	R_2/R_1		0.8	1.0	1.2	-
Gain-Bandwidth Product	f_T	$V_{CE} = -10\text{V}, I_E = -5\text{mA}$ $f = 100\text{MHz}$	-	250	-	MHz

Ratings and Characteristic Curves (@ $T_A = 25^\circ\text{C}$ unless otherwise specified)

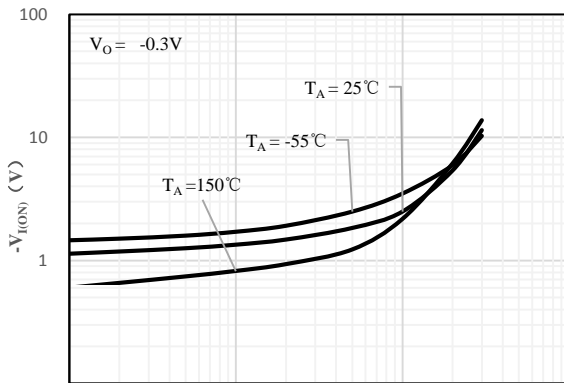

Fig 1 Input Voltage vs Output Current

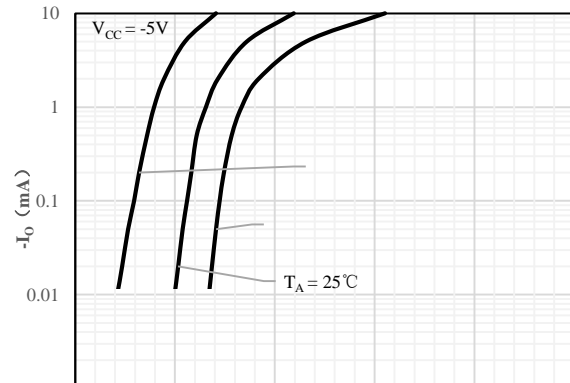

Fig 2 Output Current vs Input Voltage

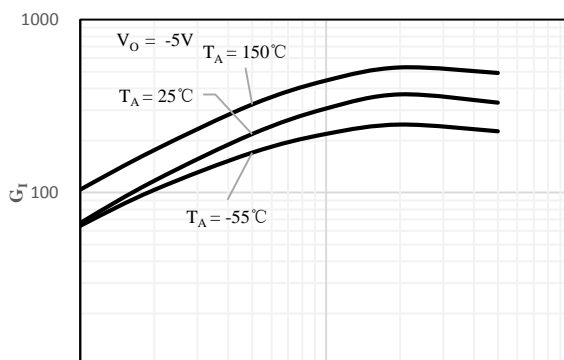

Fig 3 DC Current Gain vs Output Current

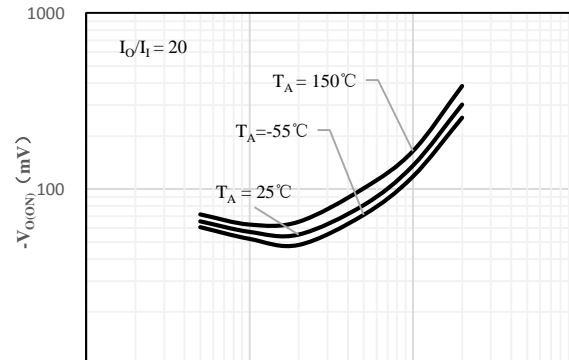
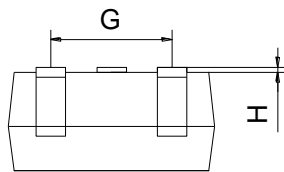
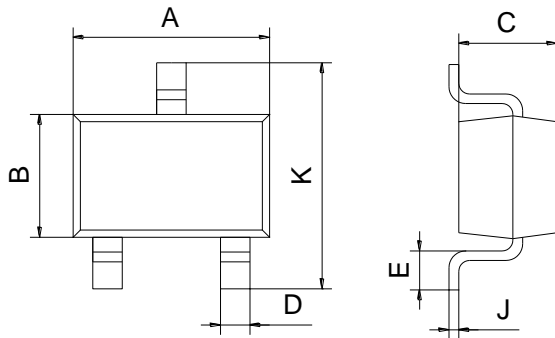
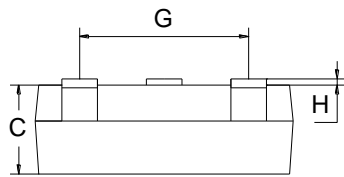
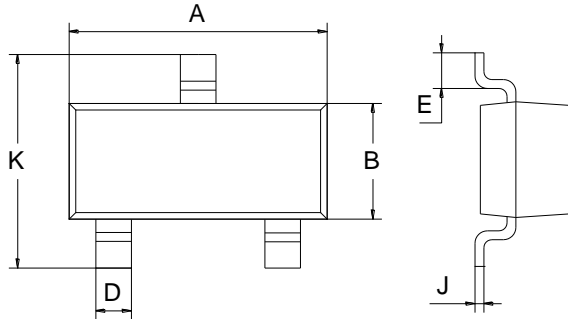

Fig 4 Output Voltage vs Output Current



Package Outline Dimensions (Unit: mm)



SOT-23		
Dimension	Min.	Max.
A	2.70	3.10
B	1.10	1.50
C	0.90	1.10
D	0.30	0.50
E	0.35	0.48
G	1.80	2.00
H	0.02	0.10
J	0.05	0.15
K	2.20	2.60

SOT-323		
Dimension	Min.	Max.
A	2.00	2.20
B	1.15	1.35
C	0.90	1.10
D	0.15	0.35
E	0.25	0.40
G	1.20	1.40
H	0.02	0.10
J	0.05	0.15
K	2.20	2.40

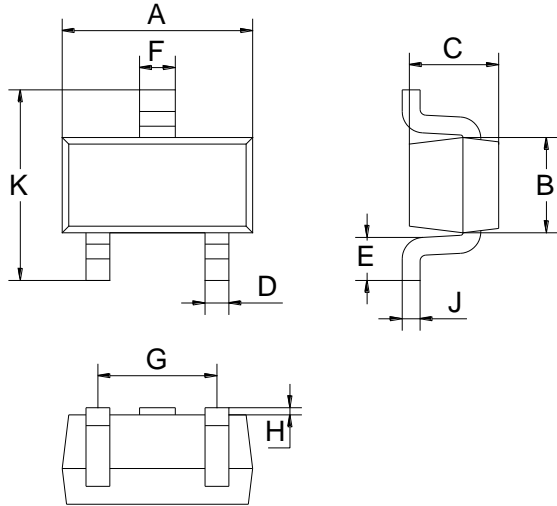

SOT-523		
Dimension	Min.	Max.
A	1.50	1.70
B	0.75	0.85
C	0.60	0.80
D	0.15	0.30
E	0.30	0.40
F	0.25	0.40
G	0.90	1.10
H	0.02	0.10
J	0.08	0.18
K	1.45	1.75

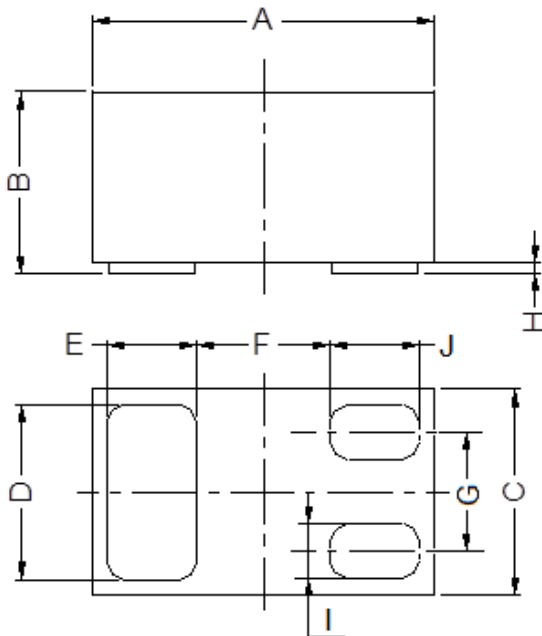

DFN1006-3			
Dimension	Min.	Typ.	Max.
A	0.95	1.00	1.075
B	0.47	0.50	0.53
C	0.55	0.60	0.675
D	0.45	0.50	0.55
E/J	0.20	0.25	0.30
F	-	0.40	-
G	-	0.35	-
H	0	0.03	0.05
I	0.10	0.15	0.20

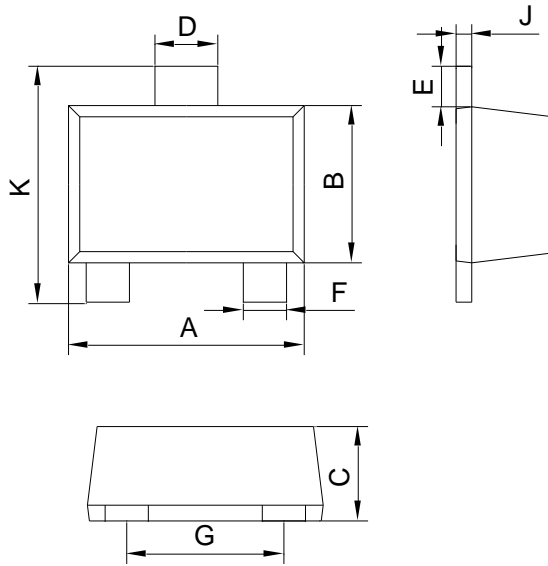

SOT-723		
Dimension	Min.	Max.
A	1.10	1.30
B	0.70	0.90
C	0.40	0.54
D	0.22	0.42
E	0.10	0.30
F	0.12	0.32
G	0.70	0.90
J	0.08	0.15
K	1.10	1.30

Mounting Pad Layout (Unit: mm)

SOT-23

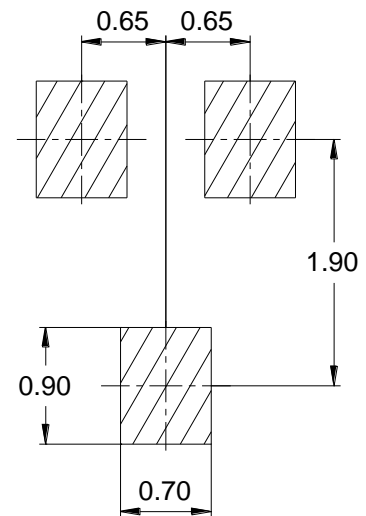
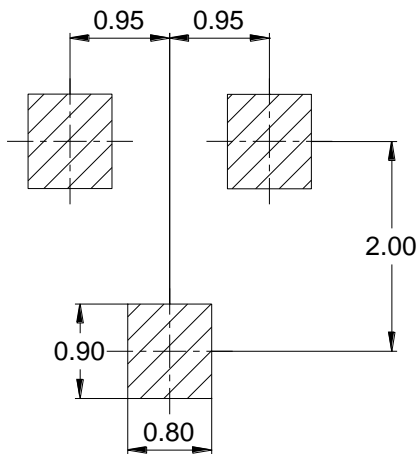



SOT-723

